

Internet Indirection Infrastructure

Ion Stoica, Daniel Adkins, Shelley Zhuang, Scott Shenker, *Fellow, IEEE*, and Sonesh Surana

Abstract—Attempts to generalize the Internet’s point-to-point communication abstraction to provide services like multicast, anycast, and mobility have faced challenging technical problems and deployment barriers. To ease the deployment of such services, this paper proposes a general, overlay-based Internet Indirection Infrastructure (*i3*) that offers a rendezvous-based communication abstraction. Instead of explicitly sending a packet to a destination, each packet is associated with an identifier; this identifier is then used by the receiver to obtain delivery of the packet. This level of *indirection* decouples the act of sending from the act of receiving, and allows *i3* to efficiently support a wide variety of fundamental communication services. To demonstrate the feasibility of this approach, we have designed and built a prototype based on the Chord lookup protocol.

Index Terms—Anycast, indirection, mobility, multicast, network infrastructure, service composition.

I. INTRODUCTION

THE original Internet architecture was designed to provide *unicast* point-to-point communication between fixed locations. In this basic service, the sending host knows the IP address of the receiver and the job of IP routing and forwarding is simply to deliver packets to the (fixed) location of the desired IP address. The simplicity of this point-to-point communication abstraction contributed greatly to the scalability and efficiency of the Internet.

However, many applications would benefit from more general communication abstractions, such as multicast, anycast, and host mobility. In these abstractions, the sending host no longer knows the identity of the receiving hosts (multicast and anycast) and the location of the receiving host need not be fixed (mobility). Thus, there is a significant and fundamental mismatch between the original point-to-point abstraction and these more general ones. All attempts to implement these more general abstractions have relied on a layer of *indirection* that decouples the sending hosts from the receiving hosts; for example, senders send to a group address (multicast or anycast) or a home agent (mobility), and the IP layer of the network is responsible for delivering the packet to the appropriate location(s).

Although these more general abstractions would undoubtedly bring significant benefit to end-users, it remains unclear how to

achieve them. These abstractions have proven difficult to implement scalably at the IP layer [6], [14], [29]. Moreover, deploying additional functionality at the IP layer requires a level of community-wide consensus and commitment that is hard to achieve. In short, implementing these more general abstractions at the IP layer poses difficult technical problems and major deployment barriers.

In response, many researchers have turned to application-layer solutions (either end-host or overlay mechanisms) to support these abstractions [6], [17], [26]. Overlay networks consist of logical connections between end-hosts at the application level. While these proposals achieve the desired functionality, they do so in a very disjointed fashion in that solutions for one service are not solutions for other services; e.g., proposals for application-layer multicast do not address mobility, and *vice versa*. As a result, many similar and largely redundant mechanisms are required to achieve these various goals. In addition, if overlay solutions are used, adding a new abstraction requires the deployment of an entirely new overlay infrastructure.

In this paper, we propose a single new overlay network that serves as a general-purpose Internet Indirection Infrastructure (*i3*). *i3* offers a powerful and flexible *rendezvous*-based communication abstraction; applications can easily implement a variety of communication services, such as multicast, anycast, and mobility, on top of this communication abstraction. Our approach provides a general overlay service that avoids both the technical and deployment challenges inherent in IP-layer solutions and the redundancy and lack of synergy in more traditional application-layer approaches. We, thus, hope to combine the generality of IP-layer solutions with the deployability of overlay solutions.

The paper is organized as follows. In Sections II and III we provide an overview of the *i3* architecture and then a general discussion on how *i3* might be used in applications. Section IV covers additional aspects of the design such as scalability and efficient routing. Section V describes some simulation results on *i3* performance along with a discussion on an initial implementation. Related work is discussed in Section VI, followed by a discussion on future work Section VII. We conclude with a summary in Section VIII.

II. *i3* OVERVIEW

In this section we present an overview of *i3*. We start with the basic service model and communication abstraction, then briefly describe the design of *i3*.

A. Service Model

The purpose of *i3* is to provide indirection; that is, it decouples the act of sending from the act of receiving. The *i3* service

Manuscript received October 3, 2002; revised December 17, 2002; approved by IEEE TRANSACTIONS ON NETWORKING Editor J. Rexford. This work was supported by the National Science Foundation under Grants ITR-00225660, ITR-0205519, ANI-0207399, ITR-0121555, ITR-0081698, ANI-0196514, NSF Career Award ANI-0133811, and a Hertz Foundation Fellowship.

I. Stoica, D. Adkins, S. Zhuang, and S. Surana are with the Department of Electrical Engineering and Computer Science, University of California, Berkeley, CA 94720 USA (e-mail: istoica@cs.berkeley.edu; dadkins@cs.berkeley.edu; shelleyz@cs.berkeley.edu; sonesh@cs.berkeley.edu.)

S. Shenker is with the International Computer Science Institute, Berkeley, CA 94704 USA (e-mail: shenker@icsi.berkeley.edu).

Digital Object Identifier 10.1109/TNET.2004.826279

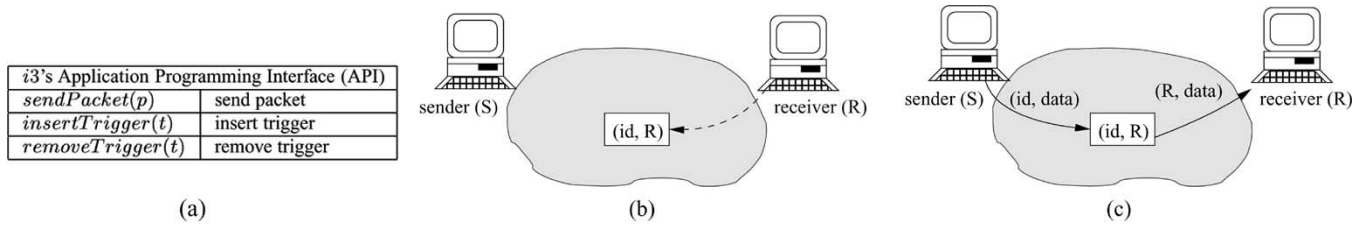

Fig. 1. (a) *i3*'s API. Example illustrating communication between two nodes. (b) The receiver *R* inserts trigger (*id, R*). (c) The sender sends packet (*id, data*).

model is simple: sources send packets to a logical *identifier*, and receivers express interest in packets sent to an identifier. Delivery is best-effort like in today's Internet, with no guarantees about packet delivery.

This service model is similar to that of IP multicast. The crucial difference is that the *i3* equivalent of an IP multicast join is more flexible. IP multicast offers a receiver a binary decision of whether or not to receive packets sent to that group (this can be indicated on a per-source basis). It is up to the multicast infrastructure to build efficient delivery trees. The *i3* equivalent of a join is inserting a *trigger*. This operation is more flexible than an IP multicast join as it allows receivers to control the routing of the packet. This provides two advantages. First, it allows end-hosts to create, at the application level, services such as mobility, anycast, and service composition out of this basic service model. Thus, this one simple service model can be used to support a wide variety of application-level communication abstractions, alleviating the need for many parallel and redundant overlay infrastructures. Second, the infrastructure can give responsibility for efficient tree construction to the end-hosts. This allows the infrastructure to remain simple, robust, and scalable.

B. Rendezvous-Based Communication

The service model is instantiated as a rendezvous-based communication abstraction. In their simplest form, packets are pairs (*id, data*) where *id* is an *m*-bit identifier and *data* consists of a payload (typically a normal IP packet payload). Receivers use *triggers* to indicate their interest in packets. In the simplest form, triggers are pairs (*id, addr*), where *id* represents the trigger identifier, and *addr* represents a node's address which consists of an IP address and a port number. A trigger (*id, addr*) indicates that all packets with an identifier *id* should be forwarded (at the IP level) by the *i3* infrastructure to the node identified by *addr*. More specifically, the rendezvous-based communication abstraction exports three basic primitives as shown in Fig. 1(a).

Fig. 1(b) illustrates the communication between two nodes, where receiver *R* wants to receive packets sent to *id*. The receiver inserts the trigger (*id, R*) into the network. When a packet is sent to identifier *id*, *i3* forward the packet via IP to *R*.

Thus, much as in IP multicast, the identifier *id* represents a logical rendezvous between the sender's packets and the receiver's trigger. This level of indirection decouples the sender from the receiver. The senders need neither be aware of the number of receivers nor their location. Similarly, receivers need not be aware of the number or location of senders.

The above description is the simplest form of the abstraction. We now describe a generalization that allows inexact matching

between identifiers. (A second generalization that replaces identifiers with a stack of identifiers is described in Section II-E) We assume identifiers are *m* bits long and that there is some *exact-match threshold* *k* with $k < m$. We then say that an identifier *id_t* in a trigger *matches* an identifier *id* in a packet if and only if

- 1) *id* and *id_t* have a prefix match of at least *k* bits;
- 2) there is no trigger with an identifier that has a longer prefix match with *id*.

In other words, a trigger identifier *id_t* matches a packet identifier *id* if and only if *id_t* is a longest prefix match (among all other trigger identifiers) and this prefix match is at least as long as the exact-match threshold *k*. The value *k* is chosen to be large enough so that the probability that two randomly chosen identifiers match is negligible.¹ This allows end-hosts to choose the identifiers independently with negligible chance of collision.

C. Overview of the Design

We now briefly describe the infrastructure that supports this rendezvous communication abstraction; a more in-depth description follows in Section IV. *i3* is an overlay network which consists of a set of servers that store triggers and forward packets (using IP) between *i3* nodes and end-hosts. Identifiers and triggers have meaning only in this *i3* overlay.

One of the main challenges in implementing *i3* is to *efficiently* match the identifiers in packets to those in triggers. This is done by mapping each identifier to a unique *i3* node (server); at any given time there is a single *i3* node responsible for a given *id*. When a trigger (*id, addr*) is inserted, it is stored on the *i3* node responsible for *id*. When a packet is sent to *id* it is routed by *i3* to the node responsible for *id*; there it is matched against any triggers for that *id* and forwarded (using IP) to all hosts interested in packets sent to that identifier. To facilitate inexact matching, we require that all *id*'s that agree in the first *k* bits be stored on the same *i3* server. The longest prefix match required for inexact matching can then be executed at a single node (where it can be done efficiently).

Note that packets are not stored in *i3*; they are only forwarded. *i3* provides a best-effort service like today's Internet. *i3* implements neither reliability nor ordered delivery on top of IP. End-hosts use periodic refreshing to maintain their triggers in *i3*. Hosts contact an *i3* node when sending *i3* packets or inserting triggers. This *i3* node then forward these packets or triggers to the *i3* node responsible for the associated identifiers. Thus, hosts need only know one *i3* node in order to use the infrastructure.

¹In our implementation we choose $m = 256$ and $k = 128$.

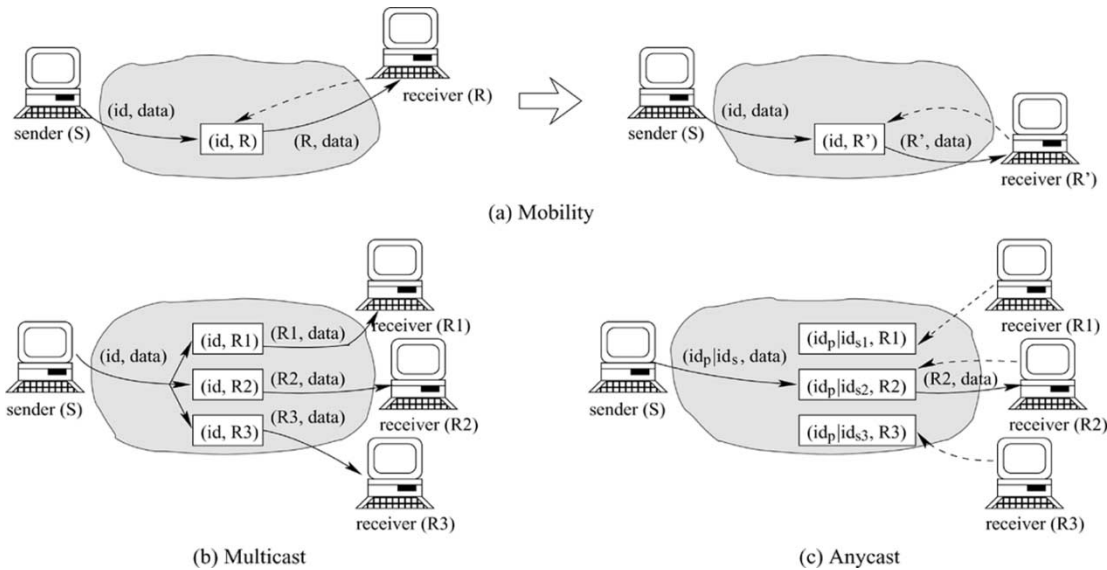

Fig. 2. Communication abstractions provided by *i3*. (a) Mobility: the change of the receiver’s address from R to R' is transparent to the sender. (b) Multicast: every packet $(id, data)$ is forwarded to each receiver R_i that inserts the trigger (id, R_i) . (c) Anycast: the packet matches the trigger of receiver R_2 . $id_p|id_s$ denotes an identifier of size m , where id_p represents the prefix of the k most significant bits, and id_s represents the suffix of the $m - k$ least significant bits.

D. Communication Primitives Provided by *i3*

We now describe how *i3* can be used by applications to achieve the more general communication abstractions of mobility, multicast, and anycast.

1) *Mobility*: The form of mobility addressed here is when a host (e.g., a laptop) is assigned a new address when it moves from one location to another. A mobile host that changes its address from R to R' as a result of moving from one subnet to another can preserve end-to-end connectivity by simply updating each of its existing triggers from (id, R) to (id, R') , as shown in Fig. 2(a). The sending host needs not be aware of the mobile host’s current location or address. Furthermore, since each packet is routed based on its identifier to the server that stores its trigger, no additional operation needs to be invoked when the sender moves. Thus, *i3* can maintain end-to-end connectivity even when both end-points move simultaneously.

With any scheme that supports mobility, efficiency is a major concern [27]. With *i3*, applications can use two techniques to achieve efficiency. First, the address of the server storing the trigger is cached at the sender, and, thus, subsequent packets are forwarded directly to that server via IP. This way, most packets are forwarded through only one *i3* server in the overlay network. Second, to alleviate the triangle routing problem due to the trigger being stored at a server far away, end-hosts can use off-line heuristics to choose triggers that are stored at *i3* servers close to themselves (see Section IV-E for details).

2) *Multicast*: Creating a multicast group is equivalent to having all members of the group register triggers with the same identifier id . As a result, any packet that matches id is forwarded to all members of the group as shown in Fig. 2(b). We discuss how to make this approach scalable in Section III-D.

Note that unlike IP multicast, with *i3* there is no difference between unicast or multicast packets, in either sending or receiving. Such an interface gives maximum flexibility to the application. An application can switch on-the-fly from unicast to multicast by simply having more hosts maintain triggers with

the same identifier. For example, in a telephony application this would allow multiple parties to seamlessly join a two-party conversation. In contrast, with IP, an application has to at least change the IP destination address in order to switch from unicast to multicast.

3) *Anycast*: Anycast ensures that a packet is delivered to exactly one receiver in a group, if any [2], [19], [23]. Anycast enables server selection, a basic building block for many of today’s applications. To achieve this with *i3*, all hosts in an anycast group maintain triggers which are identical in the k most significant bits. These k bits play the role of the anycast group identifier. To send a packet to an anycast group, a sender uses an identifier whose k -bit prefix matches the anycast group identifier. The packet is then delivered to the member of the group whose trigger identifier best matches the packet identifier according to the longest prefix matching rule (see Fig. 2(c)). Section III-C gives two examples of how end-hosts can use the last $m - k$ bits of the identifier to encode their preferences.

E. Stack of Identifiers

In this section, we describe a second generalization of *i3*, which replaces identifiers with identifier *stacks*. An identifier stack is a list of identifiers that takes the form $(id_1, id_2, id_3, \dots, id_k)$ where id_i is either an identifier or an address. Packets p and triggers t are, thus, of the form:

- packet $p = (id_{stack}, data)$;
- trigger $t = (id, id_{stack})$.

The generalized form of packets allows a source to send a packet to a series of identifiers, much as in source routing. The generalized form of triggers allows a trigger to forward a packet to another identifier rather than to an address. This extension allows for a much greater flexibility. To illustrate this point, in Sections III-A, III-B, and IV-C, we discuss how identifier stacks can be used to provide service composition, implement heterogeneous multicast, and increase *i3*’s robustness, respectively.

```

i3_recv(p) // upon receiving packet p
  id = head(p.id_stack); // get head of p's stack
  // is local server responsible for id's best match?
  if (isMatchLocal(id) = FALSE)
    i3_forward(p); // matching trigger stored elsewhere
  return;
  pop(p.id_stack); // pop id from p's stack...
  set_t = get_matches(id); // get all triggers matching id
  if (set_t = ∅)
    if (p.id_stack = ∅)
      drop(p) // nowhere else to forward
    else
      i3_forward(p);
  while (set_t ≠ ∅) // forward packet to each matching trigger
    t = get_trigger(set_t);
    p1 = copy(p); // create new packet to send
    // ... add t's stack at head of p1's stack
    prepend(t.id_stack, p1.id_stack);
    i3_forward(p1);

i3_forward(p) // send/forward packet p
  id = head(p.id_stack); // get head of p's stack
  if (type(id) = IP_ADDR_TYPE)
    IP_send(id, p); // id is an IP address; send p to id via IP
  else
    forward(p); // forward p via overlay network

```

Fig. 3. Pseudocode of the receiving and forward operations executed by an *i3* server.

A packet p is always forwarded based on the first identifier in its identifier stack until it reaches the server who is responsible for storing the matching trigger(s) for p . Consider a packet p with an identifier stack (id_1, id_2, id_3) . If there is no trigger in *i3* whose identifier matches id_1 , id_1 is popped from the stack. The process is repeated until an identifier in p 's identifier stack matches a trigger t . If no such trigger is found, packet p is dropped. If on the other hand, there is a trigger t whose identifier matches id_1 , then id_1 is replaced by t 's identifier stack. In particular, if t 's identifier stack is (x, y) , then p 's identifier stack becomes (x, y, id_2, id_3) . If id_1 is an IP address, p is sent via IP to that address, and the rest of p 's identifier stack, i.e., (id_2, id_3) is forwarded to the application. The semantics of id_2 and id_3 are in general application-specific. However, in this paper we consider only examples in which the application is expected to use these identifiers to forward the packet after it has processed it. Thus, an application that receives a packet with identifier stack (id_2, id_3) is expected to send another packet with the same identifier stack (id_2, id_3) . As shown in Section III this allows *i3* to provide support for service composition.

Fig. 3 shows the pseudocode of the receiving and forwarding operations executed by an *i3* node. Upon receiving a packet p , a server first checks whether it is responsible for storing the trigger matching packet p . If not, the server forward the packet at the *i3* level. If yes, the code returns the set of triggers that match p . For each matching trigger t , the identifier stack of the trigger is prepended to p 's identifier stack. The packet p is then forwarded based on the first identifier in its stack.

III. USING *i3*

In this section we present a few examples of how *i3* can be used. We discuss service composition, heterogeneous multicast, server selection, and large scale multicast. In the remainder of

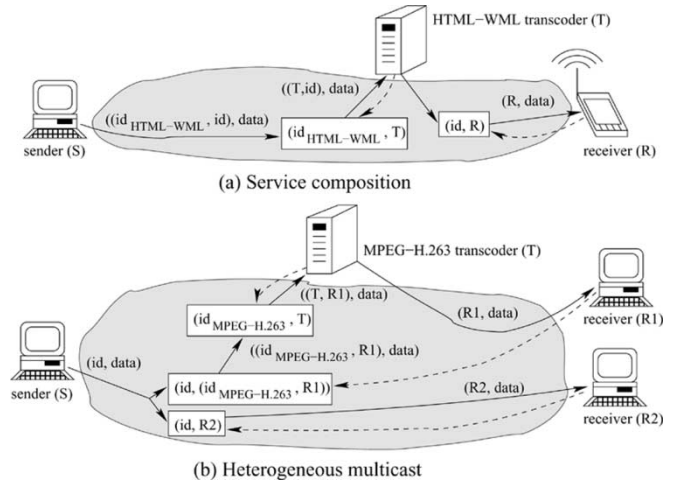

Fig. 4. (a) Service composition: the sender (S) specifies that packets should be transcoded at server T before being delivered to the destination (R). (b) Heterogeneous multicast: receiver $R1$ specifies that wants to receive H.263 data, while $R2$ specifies that wants to receive MPEG data.

the paper, we say that packet p matches trigger t if the first identifier of p 's identifier stack matches t 's identifier.

A. Service Composition

Some applications may require third parties to process the data before it reaches the destination [11]. An example is a wireless application protocol (WAP) gateway translating HTML web pages to WML for wireless devices [34]. WML is a light-weight version of HTML designed to run on wireless devices with small screens and limited capabilities. In this case, the server can forward the web page to a third-party server T that implements the HTML-WML transcoding, which in turn processes the data and sends it to the destination via WAP.

In general, data might need to be transformed by a series of third-party servers before it reaches the destination. In today's Internet, the application needs to know the set of servers that perform transcoding and then explicitly forward data packets via these servers.

With *i3*, this functionality can be easily implemented by using a stack of identifiers. Fig. 4(a) shows how data packets containing HTML information can be redirected to the transcoder, and, thus, arrive at the receiver containing WML information. The sender associates with each data packet the stack $(id_{HTML-WML}, id)$, where id represents the flow identifier. As a result, the data packet is routed first to the server which performs the transcoding. Next, the server inserts packet $(id, data)$ into *i3*, which delivers it to the receiver.

B. Heterogeneous Multicast

Fig. 4(b) shows a more complex scenario in which an MPEG video stream is played back by one H.263 receiver and one MPEG receiver.

To provide this functionality, we use the ability of the receiver, instead of the sender (see Section II-E), to control the transformations performed on data packets. In particular, the H.263 receiver $R1$ inserts trigger $(id, (id_{MPEG-H.263}, R1))$, and the sender sends packets $(id, data)$. Each packet matches $R1$'s trigger, and as a result the packet's identifier id is

replaced by the trigger's stack ($id_{\text{MPEG-H.263}}, T$). Next, the packet is forwarded to the MPEG-H.263 transcoder, and then directly to receiver $R1$. In contrast, an MPEG receiver $R2$ only needs to maintain a trigger ($id, R1$) in $i3$. This way, receivers with different display capabilities can subscribe to the same multicast group.

Another useful application is to have the receiver insist that all data go through a firewall first before reaching it.

C. Server Selection

$i3$ provides good support for basic server selection through the use of the last $m - k$ bits of the identifiers to encode application preferences.² To illustrate this point consider two examples.

In the first example, assume that there are several web servers and the goal is to balance the client requests among these servers. This goal can be achieved by setting the $m - k$ least significant bits of both trigger and packet identifiers to random values. If servers have different capacities, then each server can insert a number of triggers proportional to its capacity. Finally, one can devise an adaptive algorithm in which each server varies the number of triggers as a function of its current load.

In the second example, consider the goal of selecting a server that is close to the client in terms of latency. To achieve this goal, each server can use the last $m - k$ bits of its trigger identifiers to encode its location, and the client can use the last $m - k$ bits in the packets' identifier to encode its own location. In the simplest case, the location of an end-host (i.e., server or client) can be the zip code of the place where the end-host is located; the longest prefix matching procedure used by $i3$ would result then in the packet being forwarded to a server that is relatively close to the client.³

D. Large Scale Multicast

The multicast abstraction presented in Section II-D2 assumes that all members of a multicast group insert triggers with identical identifiers. Since triggers with identical identifier are stored at the same $i3$ server, that server is responsible for forwarding each multicast packet to every member of the multicast group. This solution obviously does not scale to large multicast groups.

One approach to address this problem is to build a hierarchy of triggers, where each member R_i of a multicast group id_g replaces its trigger (id_g, R_i) by a chain of triggers (id_g, x_1), (x_1, x_2), ..., (x_i, R_i). This substitution is transparent to the sender: a packet ($id_g, data$) will still reach R_i via the chain of triggers. Fig. 5 shows an example of a multicast tree with seven receivers in which no more than three triggers have the same identifier. This hierarchy of triggers can be constructed and maintained either cooperatively by the members of the multicast group, or by a third party provider. In [20], we present an efficient distributed algorithm in which the receivers of the multicast group construct and maintain the hierarchy of triggers.

²Recall that identifiers are m bits long and that k is the exact-matching threshold.

³Here we assume that nodes that are geographically close to each other are also close in terms of network distances, which is not always true. One could instead use latency based encoding, much as in [22].

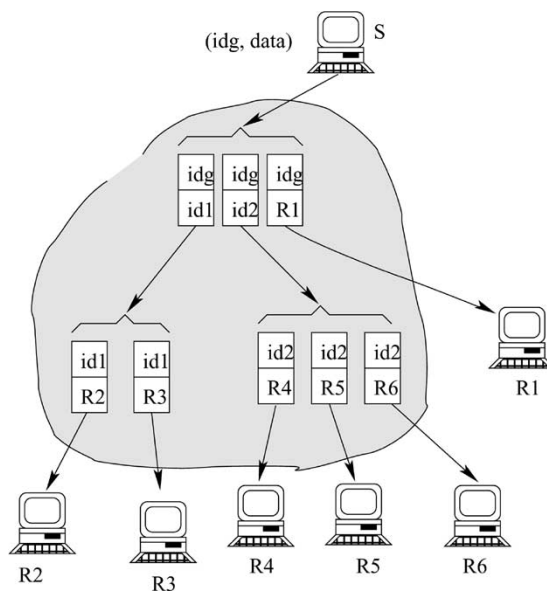

Fig. 5. Example of a scalable multicast tree with bounded degree by using chains of triggers.

IV. ADDITIONAL DESIGN AND PERFORMANCE ISSUES

In this section we discuss some additional $i3$ design and performance issues. The $i3$ design was intended to be (among other properties) robust, self-organizing, efficient, secure, scalable, incrementally deployable, and compatible with legacy applications. In this section we discuss these issues and some details of the design that are relevant to them.

Before addressing these issues, we first review our basic design. $i3$ is organized as an overlay network in which every node (server) stores a subset of triggers. In the basic design, at any moment of time, a trigger is stored at only one server. Each end-host knows about one or more $i3$ servers. When a host wants to send a packet ($id, data$), it forward the packet to one of the servers it knows. If the contacted server does not store the trigger matching ($id, data$), the packet is forwarded via IP to another server. This process continues until the packet reaches the server that stores the matching trigger. The packet is then sent to the destination via IP.

A. Properties of the Overlay

The performance of $i3$ depends greatly on the nature of the underlying overlay network. In particular, we need an overlay network that exhibits the following desirable properties:

- **Robustness:** With a high probability, the overlay network remains connected even in the face of massive server and communication failures.
- **Scalability:** The overlay network can handle the traffic generated by millions of end-hosts and applications.
- **Efficiency:** Routing a packet to the server that stores the packet's best matching trigger involves a small number of servers.
- **Stability:** The mapping between triggers and servers is relatively stable over time, that is, it is unlikely to change during the duration of a flow. This property allows end-hosts to optimize their performance by choosing triggers that are stored on nearby servers.

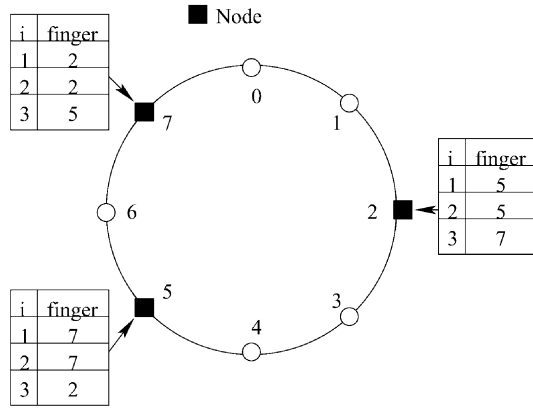

Fig. 6. Routing information (finger tables) maintained by the Chord nodes.

To implement $i3$ we have chosen the Chord lookup protocol [28], which is known to satisfy the above properties. Chord uses an m -bit circular identifier space where 0 follows $2^m - 1$. Each server is associated with a unique identifier in this space. In the original Chord protocol, each identifier id is mapped onto the server with the closest identifier that follows id on the identifier circle. This server is called the successor of id and it is denoted by $successor(id)$. Fig. 6 shows an example in which there are three nodes, and $m = 3$. Server 2 is responsible for identifiers 0, 1, and 2, server 5 is responsible for 3, 4 and 5, and server 7 is responsible for 6 and 7.

To implement the routing operation, each server maintains a routing table of size m . The i th entry in the routing table of server n contains the first server that follows $n + 2^{i-1}$, i.e., $successor(n + 2^{i-1})$. This server is called the i th finger of n . Note that the first finger is the same as the successor server.

Upon receiving a packet with identifier id , server n checks whether id lies between itself and its successor. If yes, the server forward the packet to its successor, which should store the packet's trigger. If not, n sends the packet to the closest server (finger) in its routing table that precedes id . In this way, we are guaranteed that the distance to id in the identifier space is halved at each step. As a result, it takes $O(\log N)$ hops to route a packet to the server storing the best matching trigger for the packet, irrespective of the starting point of the packet, where N is the number of $i3$ servers in the system.

In the current implementation, we assume that all identifiers that share the same k -bit prefix are stored on the same server. A simple way to achieve this is to set the last $m - k$ bits of every node identifier to zero. As a result, finding the best matching trigger reduces to performing a longest prefix matching operation locally.

While $i3$ is implemented on top of Chord, in principle $i3$ can use any of the recently proposed peer-to-peer lookup systems such as CAN [24], Pastry [25], and Tapestry [13].

B. Public and Private Triggers

Before discussing $i3$'s properties, we introduce an important technique that allows applications to use $i3$ more securely and efficiently. With this technique applications make a distinction between two types of triggers: *public* and *private*. This distinction is made only at the application level: $i3$ itself does not differentiate between public and private triggers.

The main use of a public trigger is to allow an end-host to contact another end-host. The identifier of a public trigger is known by all end-hosts in the system. An example is a web server that maintains a public trigger to allow any client to contact it. A public trigger can be defined as the hash of the host's DNS name, of a web address, or of the public key associated with a web server. Public triggers are long lived, typically days or months. In contrast, private triggers are chosen by a small number of end-hosts and are short lived. Typically, private triggers exist only for the duration of a flow.

To illustrate the difference between public and private triggers, consider a client A accessing a web server B that maintains a public trigger (id_{pub}, B). First, client A chooses a private trigger identifier id_a , inserts trigger (id_a, A) into $i3$, and sends id_a to the web server via the server's public trigger (id_{pub}, B). Once contacted, server B selects a private identifier id_b , inserts the associated trigger (id_b, B) into $i3$, and sends its private trigger identifier id_b to client A via A 's private trigger (id_a, A). The client and the server then use both the private triggers to communicate. Once the communication terminates, the private triggers are destroyed. Sections IV-E and IV-J discuss how private triggers can be used to increase the routing efficiency and the communication security.

Next, we discuss $i3$'s properties in more detail.

C. Robustness

$i3$ inherits much of the robustness properties of the overlay itself in that routing of packets within $i3$ is fairly robust against $i3$ node failures. In addition, end-hosts use periodic refreshing to maintain their triggers into $i3$. This soft-state approach allows for a simple and efficient implementation and frees the $i3$ infrastructure from having to recover lost state when nodes fail. If a trigger is lost—for example, as a result of an $i3$ server failure—the trigger will be reinserted, possibly at another server, next time the end-host refreshes it.

One potential problem with this approach is that although triggers are eventually reinserted, the time during which they are unavailable due to server failures may be too large for some applications. There are at least two solutions to address this problem. The first solution does not require $i3$ -level changes. The idea is to have each receiver R maintain a backup trigger (id_{backup}, R) in addition to the primary trigger (id, R), and have the sender send packets with the identifier stack (id, id_{backup}). If the server storing the primary trigger fails, the packet will be then forwarded via the backup trigger to R .⁴ Note that to accommodate the case when the packet is required to match every trigger in its identifier stack (see Section III-B), we use a flag in the packet header, which, if set, causes the packet to be dropped if the identifier at the head of its stack does not find a match. The second solution is to have the overlay network itself replicate the triggers and manage the replicas. In the case of Chord, the natural replication policy is to replicate a trigger on the immediate successor of the server responsible for that trigger [7]. Finally, note that when an end-host fails, its triggers are automatically deleted from $i3$ after they time out.

⁴Here we implicitly assume that the primary and backup triggers are stored on different servers. The receiver can ensure that this is the case with high probability by choosing $id_{backup} = 2^m - id$.

D. Self-Organizing

i3 is an overlay infrastructure that may grow very large. Thus, it is important that it not require extensive manual configuration or human intervention. The Chord overlay network is self-configuring, in that nodes joining the *i3* infrastructure use a simple *bootstrapping* mechanism (see [28]) to find out about at least one existing *i3* node, and then contact that node to join the *i3* infrastructure. Similarly, end-hosts wishing to use *i3* can locate at least one *i3* server using a similar bootstrapping technique; knowledge of a single *i3* server is all that is needed to fully utilize the infrastructure.

E. Routing Efficiency

As with any network system, efficient routing is important to the overall efficiency of *i3*. While *i3* tries to route each packet efficiently to the server storing the best matching trigger, the routing in an overlay network such as *i3* is typically far less efficient than routing the packet directly via IP. To alleviate this problem, the sender caches the *i3* server's IP address. In particular, each data and trigger packet carry in their headers a refreshing flag f . When a packet reaches an *i3* server, the server checks whether it stores the best matching trigger for the packet. If not, it sets the flag f in the packet header before forwarding it. When a packet reaches the server storing the best matching trigger, the server checks flag f in the packet header, and, if f is set, it returns its IP address back to the original sender. In turn, the sender caches this address and uses it to send subsequent packets with the same identifier. The sender can periodically set the refreshing flag f as a keep-alive message with the cached server responsible for this trigger.

Note that the optimization of caching the server s which stores the receiver's trigger does not undermine the system robustness. If the trigger moves to another server s' (e.g., as the result of a new server joining the system), *i3* will simply route the subsequent packets from s to s' . When the first packet reaches s' , the receiver will replace s with s' in its cache. If the cached server fails, the client simply uses another known *i3* server to communicate. This is the same fallback mechanism as in the unoptimized case when the client uses only one *i3* server to communicate with all the other clients. Actually, the fact that the client caches the *i3* server storing the receiver's trigger can help reduce the recovery time. When the sender notices that the server has failed, it can inform the receiver to reinsert the trigger immediately. Note that this solution assumes that the sender and receiver can communicate via alternate triggers that are not stored at the same *i3* server.

While caching the server storing the receiver's trigger reduces the number of *i3* hops, we still need to deal with the triangle routing problem. That is, if the sender and the receiver are close by, but the server storing the trigger is far away, the routing can be inefficient. For example, if the sender and the receiver are both in Berkeley and the server storing the receiver's trigger is in London, each packet will be forwarded to London before being delivered back to Berkeley!

One solution to this problem is to have the receivers choose their *private* triggers such that they are located on nearby servers. This would ensure that packets will not take a long detour before reaching their destination. If an end-host knows

the identifiers of the nearby *i3* servers, then it can easily choose triggers with identifiers that map onto these servers. In general, each end-host can sample the identifier space to find ranges of identifiers that are stored at nearby servers. To find these ranges, a node A can insert random triggers (id, A) into *i3*, and then estimate the RTT to the server that stores the trigger by simply sending packets, $(id, dummy)$, to itself. Note that since we assume that the mapping of triggers onto servers is relatively stable over time, this operation can be done off-line. We evaluate this approach by simulation in Section V-A.

F. Avoiding Hot Spots

Consider the problem of a large number of clients that try to contact a popular trigger such as the public trigger(s) of CNN. This may cause the server storing this trigger to overload. The classical solution to this problem is to use caching. When the rate of the packets matching a trigger t exceeds a certain threshold, the server S storing the trigger pushes a copy of t to another server. This process can continue recursively until the load is spread out. The decision of where to push the trigger is subject to two constraints. First, S should push the trigger to the server most likely to route the packets matching that trigger. Second, S should try to minimize the state it needs to maintain; S at least needs to know the servers to which it has already pushed triggers in order to forward refresh messages for these triggers (otherwise the triggers will expire). With Chord, one simple way to address these problems is to always push the triggers to the predecessor server.

If there are more triggers that share the same k -bit prefix with a popular trigger t , all these triggers need to be cached together with t . Otherwise, if the identifier of a packet matches the identifier of a cached trigger t , we cannot be sure that t is indeed the best matching trigger for the packet.

G. Scalability

Since typically each flow is required to maintain two triggers (one for each end-point), the number of triggers stored in *i3* is of the order of the number of flows plus the number of end-hosts. At first sight, this would be equivalent to a network in which each router maintains per-flow state. Fortunately, this is not the case. While the state of a flow is maintained by each router along its path, a trigger is stored at only *one* node at a time. Thus, if there are n triggers and N servers, each server will store n/N triggers on the average. This also suggests that *i3* can be easily upgraded by simply adding more servers to the network. One interesting point to note is that these nodes do not need to be placed at specific locations in the network.

H. Incremental Deployment

Since *i3* is designed as an overlay network, *i3* is incrementally deployable. At the limit, *i3* may consist of only one node that stores all triggers. Adding more servers to the system does not require any system configuration. A new server simply joins the *i3* system using the Chord protocol and becomes automatically responsible for an interval in the identifier space. When triggers with identifiers in that interval are refreshed or inserted they will be stored at the new server. In this way, the addition of a new server is also transparent to the end-hosts.

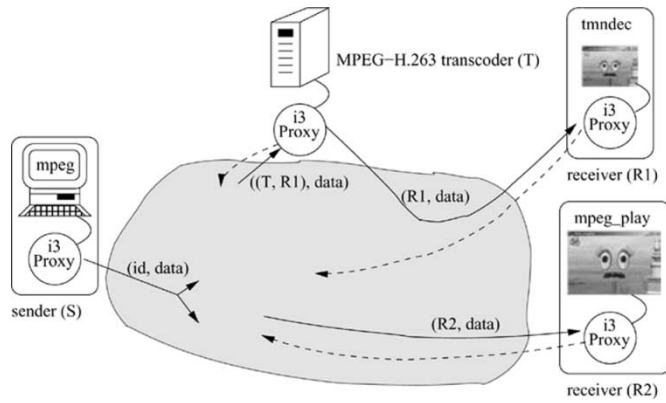

Fig. 7. Heterogeneous multicast application. Refer to Fig. 4(b) for data forwarding in *i3*.

I. Legacy Applications

The packet delivery service implemented by *i3* is best-effort, which allows existing UDP-based applications to work over *i3* easily. The end-host runs an *i3* proxy that translates between the applications' UDP packets and *i3* packets, and inserts (or refreshes) triggers on behalf of the applications. The applications do *not* need to be modified, and are unaware of the *i3* proxy. Packets are intercepted and translated by the *i3* proxy transparently. As a proof of concept, we have implemented the heterogeneous multicast application presented in Section III-B over *i3*. The sender sends a MPEG stream, and one receiver plays back with a MPEG player (`mpeg_play`) and the other with a H.263 player (`tmndec`), as shown in Fig. 7. In [37], we present a solution using *i3* to provide mobility support for TCP-based legacy applications.

J. Security

Unlike IP, where an end-host can only send and receive packets, in *i3* end-hosts are also responsible for maintaining the routing information through triggers. While this allows flexibility for applications, it also (and unfortunately) creates new opportunities for malicious users. We briefly present several security issues and list a set of techniques to address them. These techniques are discussed in detail in [1].

We deal with several different types of attacks. First, there are attacks using triggers pointing to end-hosts. Assume a legitimate end-host R maintains trigger (id, R) in *i3*. An attacker may *eavesdrop* by inserting a trigger (id, X) pointing to itself. A minor variant on eavesdropping is *impersonation*, where an attacker causes R to drop its public trigger. A third attack of this kind is *reflection*, where an attacker can sign R up for high-bandwidth streams by inserting (id', R) .

Another class of attacks abuses the ability to form arbitrary topologies with triggers. An attacker may form a *loop* by inserting triggers in a cycle. Packets sent to any of the IDs of the loop would indefinitely cycle around consuming resources. Alternatively, an attacker can construct a *confluence*. In a confluence, packets are first replicated as they would be in a multicast tree and then converge to overwhelm an end-host. Finally, an attacker can construct a chain of triggers that leads to a *dead end*. Like loops, dead ends waste resources.

In [1] we outline three techniques to solve these problems: trigger constraints, pushback, and trigger challenges.

- 1) **Constrained Triggers:** We define a constraint for a trigger (x, y) such that choosing x constrains the choice of y or *vice versa*. We divide the 256-bit ID into three fields: a 64-bit prefix, a 128-bit key, and a 64-bit suffix. *i3* servers enforce constraints such that only triggers where $y \cdot key = h_r(x)$ or $x \cdot key = h_l(y)$ are allowed. h_r and h_l are two different one-way functions publically known. As shown in [1], constrained triggers solve eavesdropping, impersonation, and undesirable topologies such as loops.
- 2) **Pushback:** To remove dead ends, we propose a simple pushback mechanism. When a data packet reaches a dead end, the dead end node sends a message to the previous *i3* node asking it to remove the previous trigger in the chain. This results in a cascading removal of triggers until all of the useless triggers are removed. Pushback addresses dead ends to triggers and also gives clients a defense against confluences and other flooding attacks.
- 3) **Trigger Challenges:** We must treat triggers pointing to end-hosts differently. To avoid abuse of this type of trigger, *i3* nodes challenge trigger insertions. Upon receiving a trigger insertion request, an *i3* node computes a challenge and sends it back to the end-host. In turn, the end-host resends the trigger insertion together with the challenge back to *i3*. Finally, *i3* accepts the trigger insertion and proceeds normally. Trigger challenges solve reflection and dead ends to nonexistent hosts.

These proposed solutions only affect the performance and functionality of *i3* in a limited way. Checking trigger constraints slows down trigger insertion slightly, while trigger challenges add an extra round trip of delay to some trigger insertions. However, note that these techniques affect only the control path performance; the performance on the data path is *not* affected. The functionality and flexibility of *i3* is preserved with the exception of service composition. Disallowing insertion of arbitrary triggers still allows sender-driven service composition but weakens receiver-driven service composition. The workaround to this problem involves maintaining per-flow triggers. We believe this limitation is acceptable for most applications.

K. Anonymity

Point-to-point communication networks such as the Internet provide limited support for anonymity. Packets usually carry the destination and the source addresses, which makes it relatively easy for an eavesdropper to learn the sender and receiver identities. In contrast, with *i3*, eavesdropping the traffic of a sender will not reveal the identity of the receiver, and eavesdropping the traffic of a receiver will not reveal the sender's identity. The level of anonymity can be further enhanced by using a chain of triggers or a stack of identifiers to route packets.

V. SIMULATION RESULTS

In this section, we evaluate the routing efficiency of *i3* by simulation. One of the main challenges in providing efficient routing is that end-hosts have little control over the location of their triggers. However, we show that simple heuristics can significantly enhance *i3*'s performance. The metric we use to evaluate these heuristics is the ratio of the inter-node latency on the *i3* network to the inter-node latency on the underlying IP network. This is called the *latency stretch*.

The simulator is based on the Chord protocol and uses iterative style routing [28]. We assume that node identifiers are randomly distributed. This assumption is consistent with the way the identifiers are chosen in other lookup systems such as CAN [24] and Pastry [25]. As discussed in [28], using random node identifiers increases system robustness and load balancing.⁵ We consider the following network topologies in our simulations:

- A power-law random graph topology generated with the INET topology generator [18] with 5000 nodes, where the delay of each link is uniformly distributed in the interval [5, 100) ms. The *i3* servers are randomly assigned to the network nodes.
- A transit-stub topology generated with the GT-ITM topology generator [12] with 5000 nodes, where link latencies are 100 ms for intra-transit domain links, 10 ms for transit-stub links and 1 ms for intra-stub domain links. *i3* servers are randomly assigned to stub nodes.

A. End-to-End Latency

Consider a source A that sends packets to a receiver R via trigger (id, R) . As discussed in Section IV-E, once the first packet reaches the server S storing the trigger (id, R) , A caches S and sends all subsequent packets directly to S . As a result, the packets will be routed via IP from A to S and then from S to R . The obvious question is how efficient is routing through S as compared to routing directly from A to R . Section IV-E presents a simple heuristic in which a receiver R samples the identifier space to find an identifier id_c that is stored at a nearby server. Then R inserts trigger (id_c, R) .

Fig. 8 plots the 90th percentile latency stretch versus the number of samples k in a system with 16384 *i3* servers. Each point represents the 90th percentile over 1000 measurements. For each measurement, we randomly choose a sender and a receiver. In each case, the receiver generates k triggers with random identifiers. Among these triggers, the receiver retains the trigger that is stored at the closest server. Then we sum the shortest path latency from the sender to S and from S to the receiver and divide it by the shortest path latency from the sender to the receiver to obtain the latency stretch. Sampling the space of identifiers greatly lowers the stretch. While increasing the number of samples decreases the stretch further, the improvement appears to saturate rapidly, indicating that in practice, just 16–32 samples should suffice. The receiver does *not* need to search for a close identifier every time a connection is open; in practice, an end-host can sample the space periodically and maintain a pool of identifiers which it can reuse.

B. Proximity Routing in *i3*

While Section V-A evaluates the end-to-end latency experienced by data packets after the sender caches the server storing

⁵We have also experimented with identifiers that have location semantics. In particular, we have used space filling curves, such as the Hilbert curve, to map a d -dimensional geometric space—which was shown to approximate the Internet latency well [22]—onto the one-dimensional Chord identifier space. However, the preliminary results do not show significant gains as compared to the heuristics presented in this section, so we omit their presentation here.

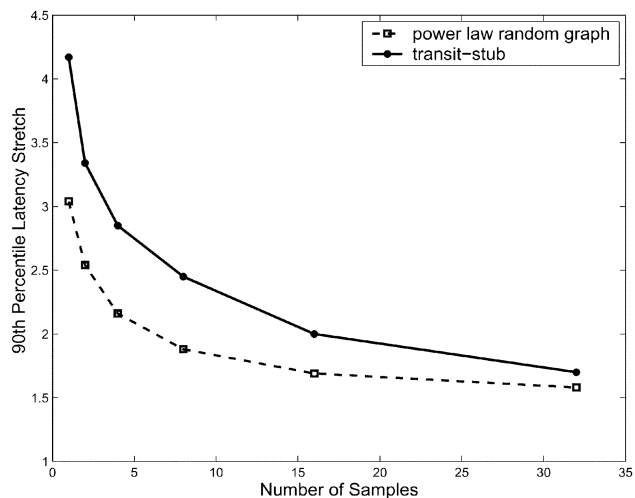

Fig. 8. The 90th percentile latency stretch versus number of samples for PLRG and transit-stub with 5000 nodes.

the receiver’s trigger t , in this section, we evaluate the latency incurred by the sender’s *first* packet that matches trigger t . This packet is routed through the overlay network until it reaches the server storing t . While Chord ensures that the overlay route length is only $O(\log N)$, where N is the number of *i3* servers, the routing *latency* can be quite large. This is because server identifiers are randomly chosen, and, therefore, servers close together in the identifier space can be far apart in the underlying network. To alleviate this problem, we consider two simple heuristics:

- **Closest finger replica:** In addition to each finger, a server maintains $r - 1$ immediate successors of that finger. Thus, each node maintains references to about $r * \log_2 N$ other nodes for routing proposes. To route a packet, a server selects the closest node in terms of network distance among (1) the finger with the largest identifier preceding the packet’s identifier and (2) the $r - 1$ immediate successors of that finger. This heuristic was originally proposed in [7].
- **Closest finger set:** Each server s chooses $\log_b N$ fingers as $successor(s + b^i)$, where $(i < \log_b N)$ and $b < 2$. To route a packet, server s considers only the closest $\log_2 N$ fingers in terms of network distances among all its $\log_b N$ fingers.

Fig. 9 plots the 90th percentile latency stretch as a function of *i3*’s size for the baseline Chord protocol and the two heuristics. The number of replicas r is 10, and b is chosen such that $\log_b N = r * \log_2 N$. Thus, with both heuristics, a server considers roughly the same number of routing entries. We vary the number of *i3* servers from 2^{10} to 2^{16} , and in each case we average routing latencies over 1000 routing queries. In all cases the *i3* server identifiers are randomly generated.

As shown in Fig. 9, both heuristics can reduce the 90th percentile latency stretch up to 2–3 times as compared to the default Chord protocol. In practice, we choose the “closest finger set” heuristic. While this heuristic achieves comparable latency stretch with “closest finger replica,” it is easier to implement and does not require to increase the routing table size. The only change in the Chord protocol is to sample the identifier space

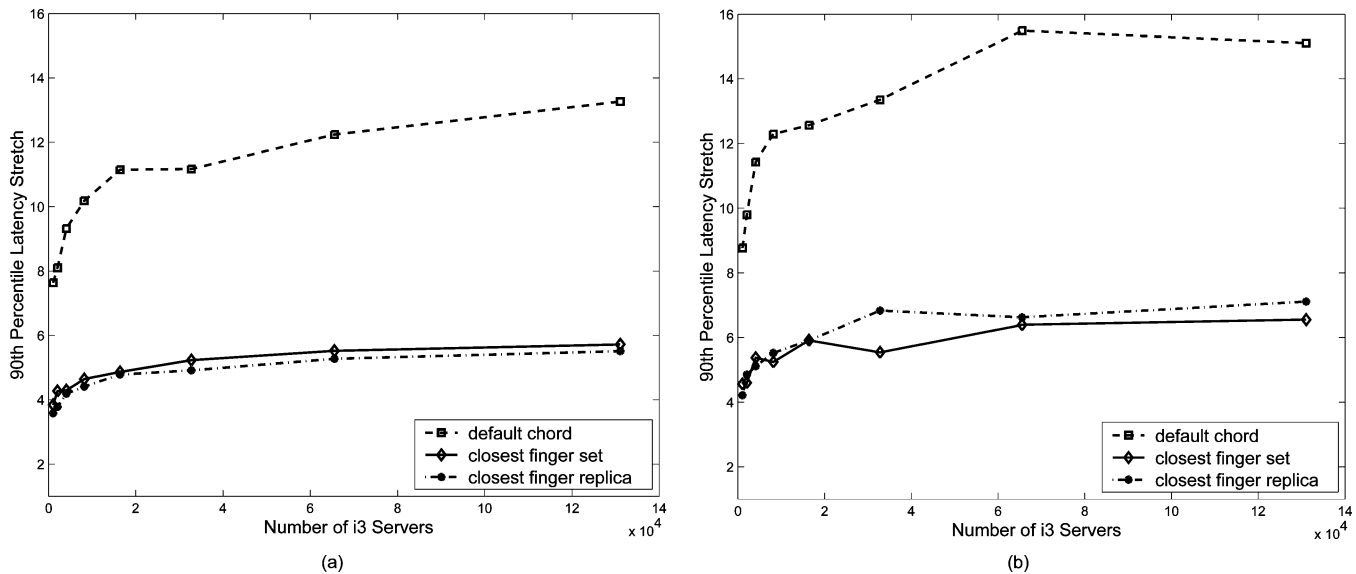

Fig. 9. The 90th percentile latency stretch in the case of (a) a power-law random network topology with 5000 nodes, and (b) a transit-stub topology with 5000 nodes. The *i3* servers are randomly assigned to all nodes in case (a), and only to the stub nodes in case (b).

using base b instead of 2, and store only the closest $\log_2 N$ fingers among the nodes sampled so far.

C. Implementation and Experiments

We have implemented a bare-bones version of *i3* using the Chord protocol. The control protocol used to maintain the overlay network is fully asynchronous and is implemented on top of UDP. The implementation uses 256 bit ($m = 256$) identifiers and assumes that the matching procedure requires exact matching on the 128 most significant bits ($k = 128$). This choice makes it very unlikely that a packet will erroneously match a trigger, and at the same time gives applications up to 128 bits to encode application specific information such as the host location (see Section II-D3).

For simplicity, in the current implementation we assume that all triggers that share the first 128 bits are stored on the same server. In theory, this allows us to use any of the proposed lookup algorithms that performs exact matching.

Both insert trigger requests and data packets share a common header of 48 bytes. In addition, data packets can carry a stack of up to four triggers (this feature is not used in the experiments). Triggers need to be updated every 30 s or they will expire. The control protocol to maintain the overlay network is minimal. Each server performs stabilization every 30 s (see [28]). During every stabilization period all servers generate approximately $N \log N$ control messages. Since in our experiments the number of servers N is in the order of tens, we neglect the overhead due to the control protocol.

The testbed used for all of our experiments was a cluster of Pentium III 700-MHz machines running Linux. We ran tests on systems of up to 32 nodes, with each node running on its own processor. The nodes communicated over a shared 1-Gb/s Ethernet. For time measurements, we use the Pentium timestamp counter (TSC). This method gives very accurate wall clock times, but sometime it includes interrupts and context switches as well. For this reason, the high extremes in the data are unreliable.

D. Performance

In the section, we present the overhead of the main operations performed by *i3*. Since these results are based on a very preliminary implementation, they should be seen as a proof of feasibility and not as a proof of efficiency. Other Chord related performance metrics such as the route length and system robustness are presented in [7].

Trigger Insertion: We consider the overhead of handling an insert trigger request locally, as opposed to forwarding a request to another server. Triggers are maintained in a hash table, so the time is practically independent of the number of triggers. Inserting a trigger involves just a hash table lookup and a memory allocation. The average and the standard deviation of the trigger insertion operation over 10 000 insertions are 12.5 and 7.12 μs , respectively. This is mostly the time it takes the operating system to process the packet and to hand it to the application. By comparison, memory allocation time is just 0.25 μs on the test machine. Note that since each trigger is updated every 30 s, a server would be able to maintain up to $30 \times 80000 = 2.4 \times 10^6$ triggers.

Data Packet Forwarding: Fig. 10 plots the overhead of forwarding a data packet to its final destination. This involves looking up the matching triggers and forwarding the packet to its destination addresses. Since we did not enable multicast, in our experiments there was never more than one address. Like trigger insertion, packet forwarding consists of a hash table lookup. In addition, this measurement includes the time to send the data packet. Packet forwarding time, in our experiments, increases roughly linearly with the packet size. This indicates that as packet size increases, memory copy operations and pushing the bits through the network dominate processing time.

***i3* Routing:** Fig. 11 plots the overhead of routing a packet to another *i3* node. This differs from data packet forwarding in that we route the packet using a node's finger table rather than its trigger table. This occurs when a data packet's trigger is stored on some other node. The most costly operation here is a linear finger table lookup, as evidenced by the graph. There are

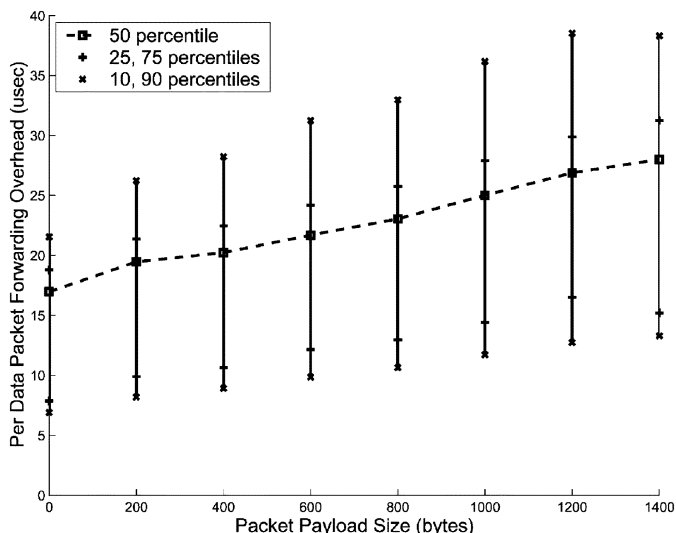

Fig. 10. Per packet forwarding overhead as a function of payload packet size. In this case, the $i3$ header sizes 48 bytes.

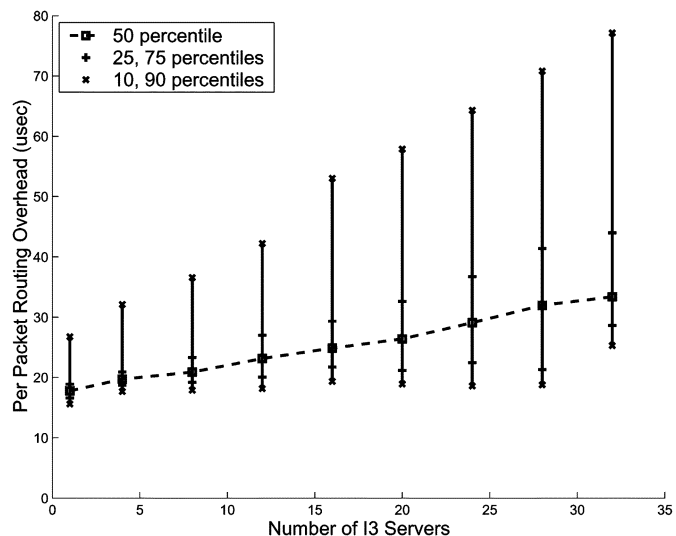

Fig. 11. Per packet routing overhead as a function of $i3$ nodes in the system. The packet payload size is zero.

two reasons for this seemingly poor behavior. First, we augment the finger table with a cache containing the most recent servers that have sent control or data packets. Since in our experiments this cache is large enough to store all servers in the system, the number of nodes used to route a packet (i.e., the fingers plus the cached nodes) increases roughly linearly with the number of nodes in the system. Second, the finger table data structure in our implementation is a list. In a more polished implementation, a more efficient data structure is clearly needed to significantly improve the performance.

Throughput: Finally, we ran some experiments to see the maximum rate at which a node can process data packets. Ideally, this should be the inverse of overhead. To test throughput, a single node is bombarded with more packets than it can reasonably handle. We measure the time it takes for 100 000 packets to emerge from the node to determine throughput. Not surprisingly, as packet payload increases, throughput in packets decreases. In addition, we calculate the data throughput

Payload Size (bytes)	Avg. Throughput (std. dev.) (pkts/sec)	Avg. Throughput (payload Mbps)
0	35,753 (2,406)	0
200	33,130 (3,035)	53.00
400	28,511 (1,648)	91.23
600	28,300 (595)	135.84
800	27,842 (1,028)	178.18
1,000	27,060 (1,127)	216.48
1,200	26,164 (1,138)	251.16
1,400	23,339 (1,946)	261.39

Fig. 12. Throughput of the data packet forwarding.

from the user perspective. Only the payload data is considered; headers are overhead to users. The user throughput in megabits per second increases as the packet payload increases because the overhead for headers and processing is roughly the same for both small and large payloads.

VI. RELATED WORK

The rendezvous-based communication is similar in spirit to the tuple space work in distributed systems [4], [16], [36]. A tuple space is a shared memory that can be accessed by any node in the system. Nodes communicate by inserting tuples and retrieving them from a tuple space, rather than by point-to-point communication. Tuples are more general than data packets. A tuple consists of arbitrary typed fields and values, while a packet consists of just an identifier and a data payload. In addition, tuples are guaranteed to be stored until they are explicitly removed. Unfortunately, the added expressiveness and stronger guarantees of tuple spaces make them very hard to efficiently implement on a large scale. Finally, with tuple spaces, a node has to explicitly ask for each data packet. This interface is not effective for high speed communications.

$i3$'s communication paradigm is similar to the publish-subscribe-notify (PSN) model. The PSN model itself exists in many proprietary forms already in commercial systems [30], [32]. While the matching operations employed by these systems are typically much more powerful than the longest prefix matching used by $i3$, it is not clear how scalable these systems are. In addition, these systems do not provide support for service composition.

Active Networks aim to support rapid development and deployment of new network applications by downloading and executing customized programs in the network [35]. $i3$ provides an alternative design that, while not as general and flexible as Active Networks, is able to realize a variety of basic communication services without the need for mobile code or any heavyweight protocols.

$i3$ is similar to many naming systems. This should come as no surprise, as identifiers can be viewed as semantic-free names. One future research direction is to use $i3$ as a unifying framework to implement various name systems.

The Domain Name system (DNS) maps hostnames to IP addresses [21]. A DNS name is mapped to an end-host as a result of an explicit request at the beginning of a transfer. In $i3$, the identifier-to-address mapping and the packet forwarding are tightly integrated. DNS resolvers form a static overlay hierarchy, while $i3$ servers form a self-organizing overlay.

Active Names (AN) map a name to a chain of mobile code responsible for locating the remote service, and transporting its response to the destination [31]. The code is executed on names at resolvers. The goals of AN and *i3* are different. In AN, applications use names to describe what they are looking for, while in *i3* identifiers are used primarily as a way to abstract away the end-host location. Also, while the goal of AN is to support extensibility for wide-area distributed services, the goal of *i3* is to support basic communication primitives such as multicast and anycast.

The Intentional Naming System (INS) is a resource discovery and service location system for mobile hosts [33]. INS uses an attribute-based language to describe names. Similar to *i3* identifiers, INS names are inserted and refreshed by the application. INS also implements a late binding mechanism that integrates the name resolution with message forwarding. *i3* differs from INS in that from the network's point of view, an identifier does not carry any semantics. This simplicity allows for a scalable and efficient implementation. Another difference is that *i3* allows end-hosts to control the application-level path followed by the packets.

The rendezvous-based abstraction is similar to the IP multicast abstraction [8]. An IP multicast address identifies the receivers of a multicast group in the same way an *i3* identifier identifies the multicast receivers. However, unlike IP which allocates a special range of addresses (i.e., class D) to multicast, *i3* does not put any restrictions on the identifier format. This gives *i3* applications the ability to switch on-the-fly from unicast to multicast. In addition, *i3* can support multicast groups with heterogeneous receivers.

Several solutions to provide the anycast service have been recently proposed. IP Anycast aims to provide this service at the IP layer [23]. All members of an anycast group share the same IP address. IP routing forwards an anycast packet to the member of the anycast group that is the closest in terms of routing distance. Global IP-Anycast (GIA) provides an architecture that addresses the scalability problems of the original IP Anycast by differentiating between rarely used and popular anycast groups [19]. In contrast to these proposals, *i3* can use distance metrics that are only available at the application level such as server load, and it supports other basic communication primitives such as multicast and service composition.

Estrin *et al.* have proposed an attribute-based data communication mechanism, called direct diffusion, to disseminate data in sensor networks [9]. Data sources and sinks use attributes to identify what information they provide or are interested in. A user that wants to receive data inserts an *interest* into the network in the form of attribute-value pairs. At a high level, attributes are similar to identifiers, and interests are similar to triggers. However, in direct diffusion, the attributes have a much richer semantic and the rules can be much more complex than in *i3*. At the implementation level, in direct diffusion, nodes flood the interests to their neighbors, while *i3* uses a lookup service to store the triggers determined based on the trigger identifier.

TRIAD [5] and IPNL [10] have been recently proposed to solve the IPv4 address scarcity problem. Both schemes use DNS names rather than addresses for global identification. However, TRIAD and IPNL make different tradeoffs. While

TRIAD is more general by allowing an unlimited number of arbitrarily connected IP network realms, IPNL provides more efficient routing by assuming a hierarchical topology with a single "middle realm." Packet forwarding in both TRIAD and IPNL is similar to packet forwarding based on identifier stacks in *i3*. However, while with TRIAD and IPNL the realm-to-realm path of a packet is determined during the DNS name resolution by network specific protocols, with *i3* the path is determined by end-hosts.

Multi-Protocol Label Switching (MPLS) was recently proposed to speed-up the IP route lookup and to perform route pinning [3]. Similar to *i3*, each packet carries a stack of labels that specifies the packet route. The first label in the stack specifies the next hop. Before forwarding a packet, a router replaces the label at the head of the stack. There are several key differences between *i3* and MPLS. While *i3* identifiers have global meaning, labels have only local meaning. In addition, MPLS requires special protocols to choose and distribute the labels. In contrast, with *i3* identifier stacks are chosen and maintained by end-hosts.

VII. DISCUSSION AND FUTURE WORK

While we firmly believe in the fundamental purpose of *i3*—providing a general-purpose indirection service through a single overlay infrastructure—the details of our design are preliminary. Besides exploring the security and efficiency issues mentioned in the paper further, there are areas that deserve significant additional attention.

A general question is what range of services and applications can be synthesized from the fixed abstraction provided by *i3*. Until now we have developed two applications on top of *i3*, a mobility solution [37], and a scalable reliable multicast protocol [20]. While the initial experience with developing these applications has been very promising, it is too early to precisely characterize the limitations and the expressiveness of the *i3* abstraction. To answer this question, we need to gain further experience with using and deploying new applications on top of *i3*.

Another question is how scalable is *i3* in practice, since *i3* must maintain state for each trigger. The following back-of-the-envelope calculation suggests that the state in *i3* will be manageable. Assume there are 10^8 end-hosts, which is the same order of magnitude as the number of hosts in the Internet [15], and that each host maintains 10 triggers on average. An *i3* system with 10000 servers would maintain $10^9/10^4 = 100000$ triggers per server on average. We believe this is a reasonable amount of state for one server to manage. Furthermore, trigger refresh messages should not be overwhelming at this level. With a refresh period of 30 s, a server can expect about 3300 trigger refreshes per second.

For inexact matching, we have used longest-prefix match. Inexact matching occurs locally, on a single node, so one could use any reasonably efficient matching procedure. The question is which inexact matching procedure will best allow applications to choose among several candidate choices. This must work for choosing based on feature sets (e.g., selecting printers), location

(e.g., selecting servers), and policy considerations (e.g., automatically directing users to facilities that match their credentials). We chose longest-prefix match mostly for convenience and familiarity, and it seems to work in the examples we have investigated, but there may be superior options.

Our initial design decision was to use semantic-free identifiers and routing; that is, identifiers are chosen randomly and routing is done based on those identifiers. Instead, one could embed location semantics into the node identifiers. This may increase the efficiency of routing by allowing routes to take lower latency *i3*-level hops, but at the cost of making the overlay harder to deploy, manage, and load balance.

Our decision to use Chord [28] to implement *i3* was motivated by the protocol simplicity, its provable properties, and by our familiarity with the protocol. However, one could easily implement *i3* on top of other lookup protocols such as CAN [24], Pastry [25], and Tapestry [13]. Using these protocols may present different benefits. For instance, using Pastry and Tapestry can reduce the latency of the first packets of a flow, since these protocols find typically routes with lower latencies than Chord. However, note that once the sender caches the server storing the receiver's trigger, there will be little difference between using different lookup protocols, as the packets will be forwarded directly via IP to that server. Studying the trade-offs involved by using various lookup protocols to implement *i3* is a topic of future research.

While these design decisions are important, they may have little to do with whether *i3* is ever deployed. We do not know what the economic model of *i3* would be and whether its most likely deployment would be as a single provider for-profit service (like content distribution networks), or a multiprovider for-profit service (like ISPs), or a cooperatively managed nonprofit infrastructure. While deployment is always hard to achieve, *i3* has the advantage that it can be incrementally deployed (it could even start as a single, centrally located server!). Moreover, it does not require the cooperation of ISPs, so third parties can more easily provide this service. Nonetheless, *i3* faces significant hurdles before ever being deployed.

VIII. SUMMARY

Indirection plays a fundamental role in providing solutions for mobility, anycast and multicast in the Internet. In this paper we propose a new abstraction that unifies these solutions. In particular, we propose to augment the point-to-point communication abstraction with a rendezvous-based communication abstraction. This level of indirection decouples the sender and receiver behaviors and allows us to provide natural support for mobility, anycast and multicast.

To demonstrate the feasibility of this approach, we have built an overlay network based on the Chord lookup system. Preliminary experience with *i3* suggests that the system is highly flexible and can support relatively sophisticated applications that require mobility, multicast, and/or anycast. In particular, we have developed a simple heterogeneous multicast application in which MPEG video traffic is transcoded on the fly to H.263 format. In addition, we have recently developed two other

applications: providing transparent mobility to legacy applications [37], and a large scale reliable multicast protocol [20].

ACKNOWLEDGMENT

The authors would like to thank S. Ratnasamy, K. Lai, K. Lakshminarayanan, A. Rao, A. Perrig, and R. Katz for their insightful comments that helped improve the *i3* design. They also thank H. Zhang, D. Song, V. Roth, L. Subramanian, S. McCanne, S. Keshav, and the anonymous reviewers for their useful comments that helped improve the paper.

REFERENCES

- [1] D. Adkins, K. Lakshminarayanan, A. Perrig, and I. Stoica, "Toward a more functional and secure network infrastructure," Univ. California, Berkeley, UCB Tech. Rep. UCB/CSD-03-1242, 2003.
- [2] S. Bhattacharjee, M. Ammar, E. Zegura, V. Shah, and Z. Fei, "Application-layer anycasting," in *Proc. IEEE INFOCOM*, Kobe, Japan, Apr. 1997, pp. 1388–1396.
- [3] R. Callon, P. Doolan, N. Feldman, A. Fredette, G. Swallow, and A. Viswanathan, "A framework for multiprotocol label switching," IETF, Internet Draft, Draft-ietf-mpls-framework-02.txt, Nov. 1997.
- [4] N. Carriero, "The implementation of tuple space machines," Ph.D. thesis, Yale Univ., New Haven, CT, 1987.
- [5] D. R. Cheriton and G. M. Triad. (2000) A new next generation Internet architecture. Stanford Univ., Stanford, CA. [Online]. Available: <http://www-dsg.stanford.edu/triad/triad.ps.gz>
- [6] Y. Chu, S. G. Rao, and H. Zhang, "A case for end system multicast," in *Proc. ACM SIGMETRICS*, Santa Clara, CA, June 2000, pp. 1–12.
- [7] F. Dabek, F. Kaashoek, D. Karger, R. Morris, and I. Stoica, "Wide-area cooperative storage with CFS," in *Proc. ACM SOSR*, Banff, Canada, 2001, pp. 202–215.
- [8] S. Deering and D. R. Cheriton, "Multicast routing in datagram internet networks and extended LANS," *ACM Trans. Computer Systems* 8, vol. 2, pp. 85–111, May 1990.
- [9] D. Estrin, R. Govindan, J. Heidemann, and S. Kumar, "Next century challenges: Scalable coordination in sensor networks," in *Proc. ACM/IEEE MOBICOM*, Cambridge, MA, Aug. 1999, pp. 263–270.
- [10] P. Francis and R. Gummadi, "IPNL: A NAT extended internet architecture," in *Proc. ACM SIGCOMM*, San Diego, CA, 2001, pp. 69–80.
- [11] S. D. Gribble, M. Welsh, J. R. von Behren, E. A. Brewer, D. E. Culler, N. Borisov, S. E. Czerwinski, R. Gummadi, J. R. Hill, A. D. Joseph, R. H. Katz, Z. M. Mao, S. Ross, and B. Y. Zhao, "The ninja architecture for robust internet-scale systems and services," *Comput. Networks*, vol. 35, no. 4, pp. 473–497, 2001.
- [12] Georgia Tech Internet Topology Model. Georgia Tech, Atlanta, GA. [Online]. Available: <http://www.cc.gatech.edu/fac/Ellen.Zegura/graphs.html>
- [13] K. Hildrum, J. D. Kubatowicz, S. Rao, and B. Y. Zhao, "Distributed object location in a dynamic network," in *Proc. 14th ACM Symp. Parallel Algorithms and Architectures*, Aug. 2002, pp. 41–52.
- [14] H. Holbrook and D. Cheriton, "IP multicast channels: EXPRESS support for large-scale single-source applications," in *Proc. ACM SIGCOMM*, Cambridge, MA, Aug. 1999, pp. 65–78.
- [15] Internet Domain Survey. [Online]. Available: <http://www.isc.org/ds>
- [16] Java Spaces. [Online]. Available: <http://www.javaspaces.homestead.com/>
- [17] J. Jannotti, D. K. Gifford, K. L. Johnson, M. F. Kaashoek, and J. J. W. O'Toole, "Overcast: Reliable multicasting with an overlay network," in *Proc. 4th USENIX Symp. Operating Systems Design and Implementation (OSDI 2000)*, San Diego, CA, Oct. 2000, pp. 197–212.
- [18] C. Jin, Q. Chen, and S. Jamin. (2000) Inet: Internet topology generator. Dept. Electr. Eng. Comput. Sci., Univ. Michigan, Ann Arbor, MI. [Online]. Available: <http://topology.eecs.umich.edu/inet>
- [19] D. Katabi and J. Wroclawski, "A framework for scalable global IP-anycast (GIA)," in *Proc. ACM SIGCOMM*, Stockholm, Sweden, Aug. 2000, pp. 3–15.
- [20] K. Lakshminarayanan, A. Rao, I. Stoica, and S. Shenker, "Flexible and robust large scale multicast using *i3*," Univ. California, Berkeley, Tech. Rep. CS-02, 2002.

- [21] P. Mockapetris and K. Dunlap, "Development of the domain name system," in *Proc. ACM SIGCOMM*, Stanford, CA, 1988, pp. 123–133.
- [22] T. S. E. Ng and H. Zhang, "Predicting internet network distance with coordinates-based approaches," in *Proc. IEEE INFOCOM*, New York, June 2002, pp. 170–179.
- [23] C. Partridge, T. Mendez, and W. Milliken, "Host anycasting service," Network Working Group, RFC 1546, 1993.
- [24] S. Ratnasamy, P. Francis, M. Handley, R. Karp, and S. Shenker, "A scalable content-addressable network," in *Proc. ACM SIGCOMM*, San Diego, CA, 2001, pp. 161–172.
- [25] A. Rowstron and P. Druschel, "Pastry: Scalable, distributed object location and routing for large-scale peer-to-peer systems," in *Proc. 18th IFIP/ACM Int. Conf. Distributed Systems Platforms (Middleware 2001)*, Nov. 2001, pp. 329–350.
- [26] A. C. Snoeren and H. Balakrishnan, "An end-to-end approach to host mobility," in *Proc. ACM/IEEE MOBICOM*, Cambridge, MA, Aug. 1999, pp. 155–166.
- [27] A. C. Snoeren, H. Balakrishnan, and M. F. Kaashoek, "Reconsidering internet mobility," in *Proc. 8th IEEE Workshop Hot Topics in Operating Systems (HotOS-VIII)*, Elmau/Oberbayern, Germany, May 2001.
- [28] I. Stoica, R. Morris, D. Karger, M. F. Kaashoek, and H. Balakrishnan, "Chord: A scalable peer-to-peer lookup service for internet applications," in *Proc. ACM SIGCOMM*, San Diego, CA, 2001, pp. 149–160.
- [29] I. Stoica, T. Ng, and H. Zhang, "REUNITE: A recursive unicast approach to multicast," in *Proc. IEEE INFOCOM*, Tel-Aviv, Israel, Mar. 2000, pp. 1644–1653.
- [30] Tibco Software. [Online]. Available: <http://www.tibco.com>
- [31] A. Vahdat, M. Dahlin, T. Anderson, and A. Aggarwal, "Active names: Flexible location and transport of wide-area resources," in *Proc. USENIX Symp. Internet Technologies and Systems*, Oct. 1999, pp. 151–164.
- [32] Vitria. [Online]. Available: <http://www.vitria.com>
- [33] W. Adjie-Winoto, E. Schwartz, H. Balakrishnan, and J. Lilley, "The design and implementation of an intentional naming system," in *Proc. ACM Symp. Operating Systems Principles (SOSP'99)*, Kiawah Island, SC, Dec. 1999, pp. 186–201.
- [34] (2001) WAP Wireless Markup Language Specification (WML). WAP Forum. [Online]. Available: <http://www.oasis-open.org/cover/wap-wml.html>
- [35] D. Wetherall, "Active network vision and reality: Lessons from a capsule-based system," in *Proc. 17th ACM Symp. Operating System Principles (SOSP'99)*, Kiawah Island, SC, Nov. 1999, pp. 64–79.
- [36] P. Wyckoff, S. W. McLaughry, T. J. Lehman, and D. A. Ford, "T spaces," *IBM Syst. J.*, vol. 37, no. 3, pp. 454–474, 1998.
- [37] S. Zhuang, K. Lai, I. Stoica, R. Katz, and S. Shenker, "Host mobility using an Internet indirection infrastructure," in *Proc. ACM MOBISYS*, San Francisco, CA, May 2003, pp. 129–144.



Ion Stoica received the Ph.D. degree from Carnegie Mellon University, Pittsburgh, PA, in 2000.

He is currently an Assistant Professor with the Department of Electrical Engineering and Computer Science, University of California, Berkeley, where he does research on resource management, scalable solutions for end-to-end quality of service, and peer-to-peer network technologies in the Internet.

Dr. Stoica is the recipient of a National Science Foundation CAREER Award in 2002, and the Association for Computing Machinery (ACM) Doctoral Dissertation Award in 2001. He is a member of the ACM.

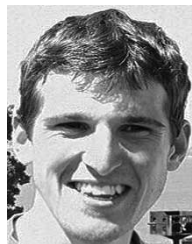

Daniel Adkins received the B.S. degree in computer science and mathematics from the Massachusetts Institute of Technology, Cambridge, in 2001. He is currently working toward the Ph.D. degree at the University of California, Berkeley.

His research interests include networking and security.



Shelley Zhuang received the B.S. degree in computer engineering and computer science from the University of Missouri, Columbia, in 1999, and is now working toward the Ph.D. degree in computer science at the University of California, Berkeley.

She has interned at NASA Goddard Space Flight Center, Microsoft, and DaimlerChrysler Research and Technology North America. Her research interests include overlay networking, content distribution networks, streaming media, multicast routing, and wireless communications.



Scott Shenker (M'87–SM'96–F'00) received the Sc.B. degree from Brown University, Providence, RI, and the Ph.D. degree from the University of Chicago, Chicago, IL, both in theoretical physics.

After a postdoctoral year in the Physics Department, Cornell University, in 1983, he joined Xerox's Palo Alto Research Center (PARC). He left PARC in 1999 to head up a newly established Internet research group at the International Computer Science Institute (ICSI), Berkeley. His research over the past 15 years has spanned the range from computer performance modeling and computer networks to game theory and economics. Most of his recent work has focused on the Internet architecture and related issues.

Dr. Shenker received the ACM SIGCOMM Award in 2002.



Sonesh Surana received the B.S. degree in computer science from Carnegie Mellon University, Pittsburgh, PA, in May 2001. He is currently working toward the Ph.D. degree in computer science at the University of California, Berkeley.

He has interned with the kernel development group of Akamai Technologies, San Mateo, CA, and with the Edge Networking Research group, IBM Research Labs, Hawthorne, NY. His research interests lie in distributed systems. Currently, he is working on load balancing in structured peer-to-peer systems.

Mr. Surana has been a student member of the Association for Computing Machinery (ACM) since 2001.