



GPU Teaching Kit
Accelerated Computing



Lecture 2.3 – Introduction to CUDA C

Threads and Kernel Functions

Objective

- To learn about CUDA threads, the main mechanism for exploiting of data parallelism
 - Hierarchical thread organization
 - Launching parallel execution
 - Thread index to data index mapping

Data Parallelism - Vector Addition Example

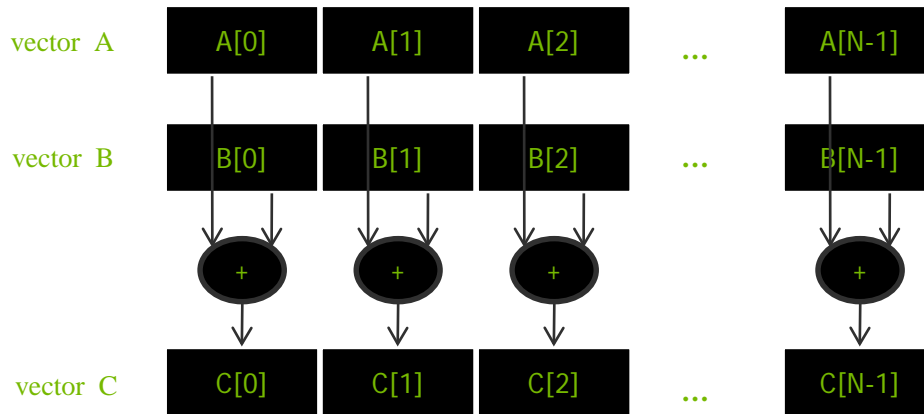

CUDA Execution Model

- Heterogeneous host (CPU) + device (GPU) application C program
 - Serial parts in **host** C code
 - Parallel parts in **device** SPMD kernel code

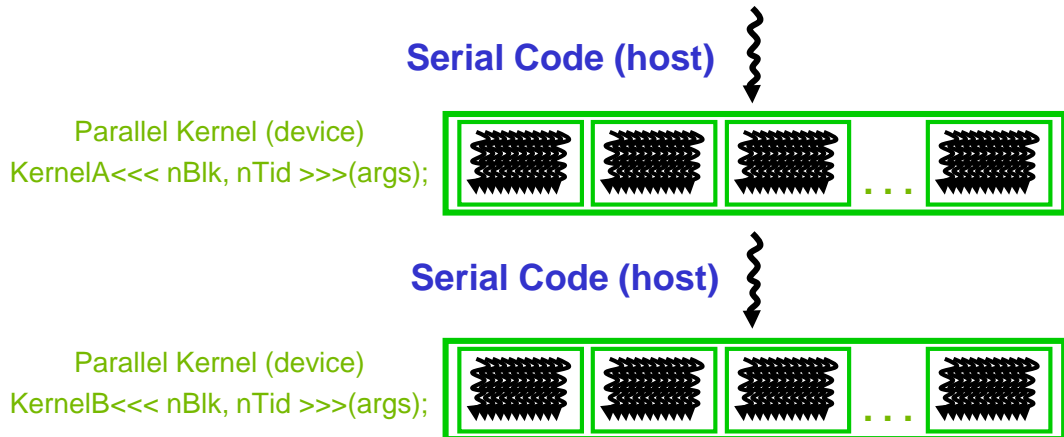

From Natural Language to Electrons

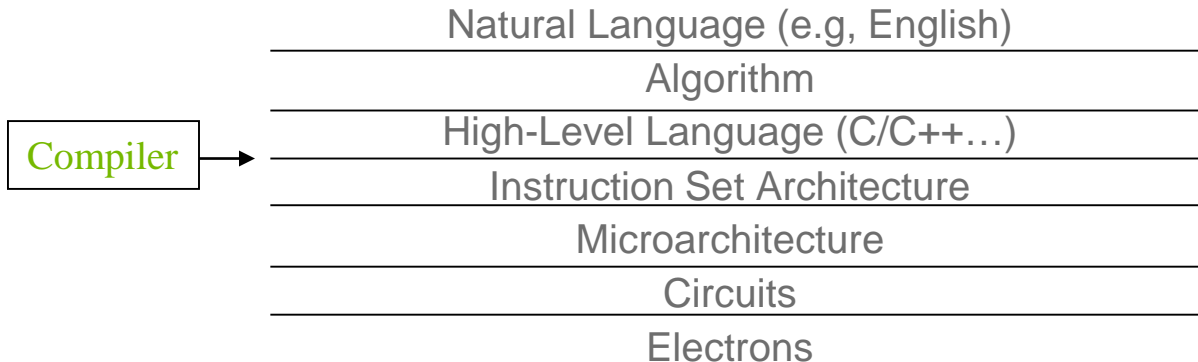

©Yale Patt and Sanjay Patel, *From bits and bytes to gates and beyond*

A program at the ISA level

- A program is a set of instructions stored in memory that can be read, interpreted, and executed by the hardware.
 - Both CPUs and GPUs are designed based on (different) instruction sets
- Program instructions operate on data stored in memory and/or registers.

A Thread as a Von-Neumann Processor

A thread is a “virtualized” or
“abstracted”
Von-Neumann Processor

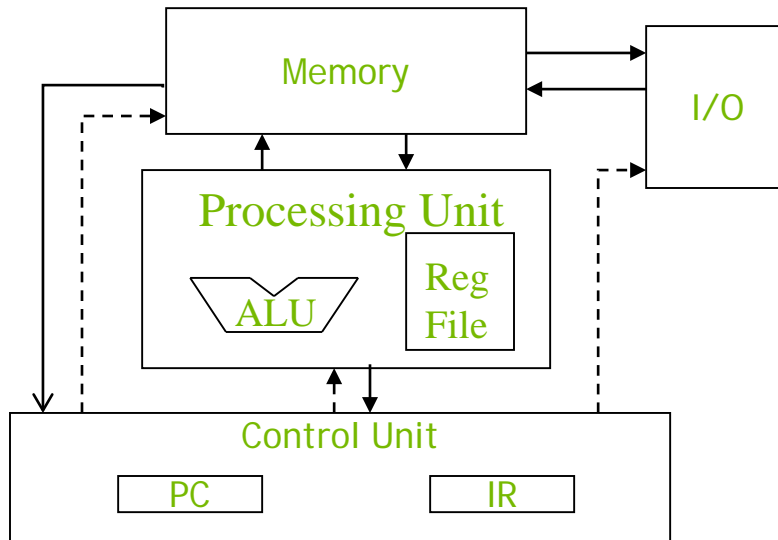

Arrays of Parallel Threads

- A CUDA kernel is executed by a **grid** (array) of threads
 - All threads in a grid run the same kernel code (Single Program Multiple Data)
 - Each thread has indexes that it uses to compute memory addresses and make control decisions

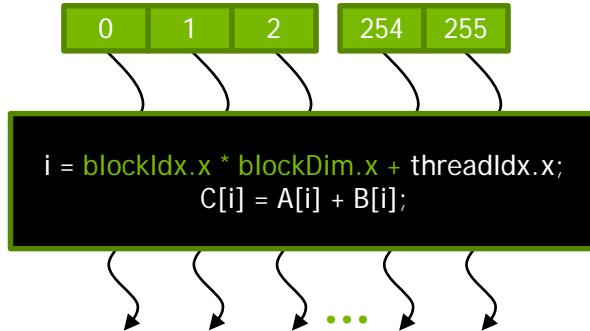

Thread Blocks: Scalable Cooperation

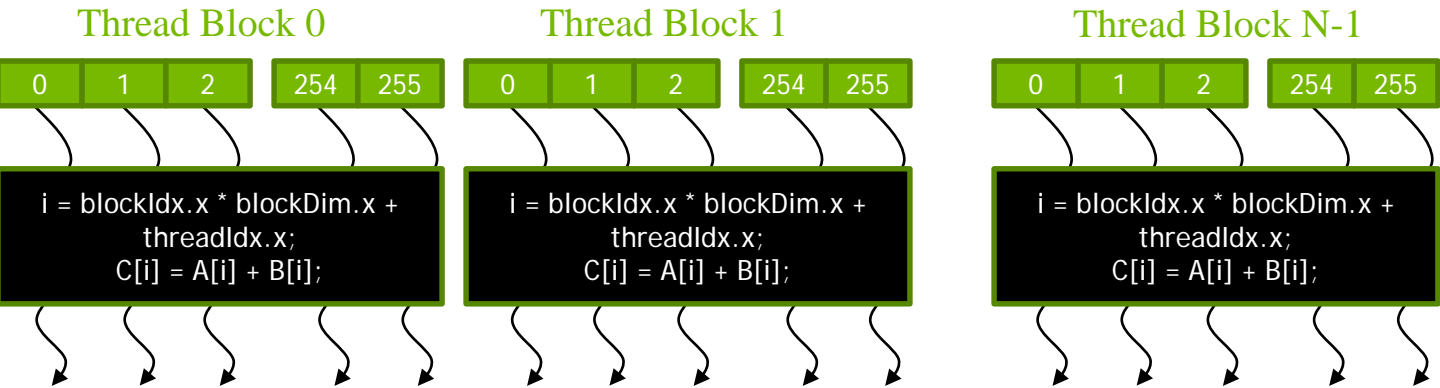

- Divide thread array into multiple blocks
 - Threads within a block cooperate via **shared memory, atomic operations** and **barrier synchronization**
 - Threads in different blocks do not interact

blockIdx and threadIdx

- Each thread uses indices to decide what data to work on
 - blockIdx: 1D, 2D, or 3D (CUDA 4.0)
 - threadIdx: 1D, 2D, or 3D
- Simplifies memory addressing when processing multidimensional data
 - Image processing
 - Solving PDEs on volumes
 - ...

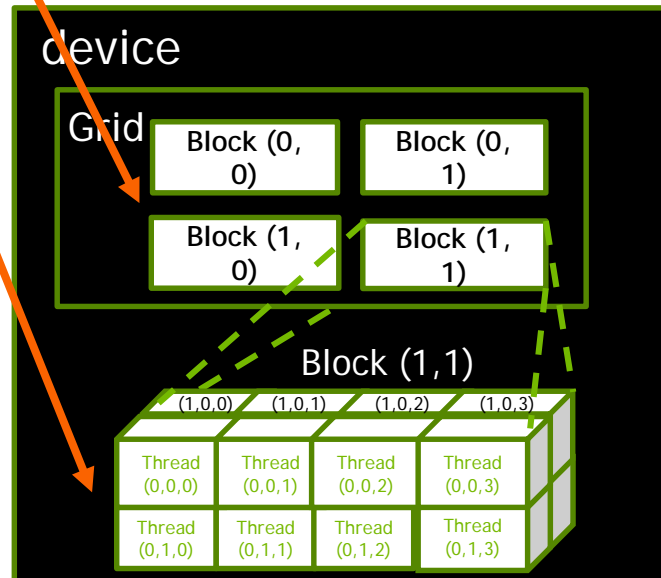



GPU Teaching Kit

Accelerated Computing



The GPU Teaching Kit is licensed by NVIDIA and the University of Illinois under the [Creative Commons Attribution-NonCommercial 4.0 International License](https://creativecommons.org/licenses/by-nc/4.0/).